

Minimal boundary cones

Cavallotto Edoardo

January 17, 2017

université
PARIS-SACLAY

Almgren minimisers

Let us fix $0 < d < n$, E will be a subset of \mathbb{R}^n with locally finite d -dimensional Hausdorff measure \mathcal{H}^d .

Admissible competitors

Let $U \subset \mathbb{R}^n$ be open. F is an admissible competitor for E on U if there exists a continuous function $\phi : [0, 1] \times U \rightarrow U$ such that:

- $\phi(0, \cdot) = Id$;
- $\exists K \subset\subset U$ such that $\forall t \phi(t, \cdot) = Id$ in K^c ;
- $\phi(1, \cdot)$ is Lipschitz and $F = \phi(1, E)$.

We call ϕ an admissible deformation.

Almgren minimiser

E is an Almgren minimiser if for every admissible competitor F we have:

$$\mathcal{H}^d(E \setminus F) \leq \mathcal{H}^d(F \setminus E).$$

Properties

If E is an Almgren minimiser then:

- E is rectifiable;
- E is Ahlfors regular;
- E is uniformly rectifiable;
- there exists an \mathcal{H}^d -negligible $N \subset \mathbb{R}^n$ such that $E \setminus N$ is a $C^{1,\alpha}$ d -dimensional submanifold of \mathbb{R}^n ;
- $\forall x \in E, \forall \mu \in \text{Tan}^d(\mathcal{H}^d \llcorner E, x)$ is supported on a minimal cone.

Remark

Let $E \subset \mathbb{R}^n$ be an Almgren minimiser. Then E is an Almgren minimiser as a subset of \mathbb{R}^m with $m > n$ (because orthogonal projections do not increase the Hausdorff area).

Minimal Cones

\mathbb{R}^2

There are only two types of minimal cones: the straight line; and three half lines meeting with angle of 120° , which we will denote as Y .

\mathbb{R}^3

There are no new 1-dimensional cones.

The 2-dimensional minimal cones are of three kinds: planes; $Y := Y \times \mathbb{R}$; the cone over the edges of a regular tetrahedron \mathbb{T} .

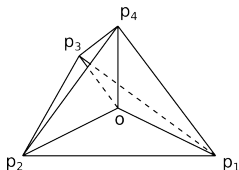
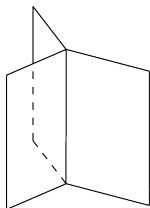

Higher dimensions

- cone over $sk_{n-2}(Q^n)$ for $n \geq 4$ [Brakke 1991];
- cone over $sk_{n-2}(\Delta_n)$ [Morgan 1994];
- for any $d, m \geq 2$ there exists $\theta(m, d) \in (0, \pi/2)$ such that, given P_1, \dots, P_m d -planes in \mathbb{R}^{md} , their union is an Almgren minimiser if all the characteristic angles are greater than $\theta(m, d)$ [Liang 2013];
- $Y \times Y \subset \mathbb{R}^4$ [Liang 2014].

Sliding deformation

Let $U \subset \mathbb{R}^n$ be open and $\Gamma_i \subset U$, $1 \leq i \leq l$, be a finite collection of closed sets. A sliding deformation with respect to $\{\Gamma_i\}_i$ is a continuous function $\phi : [0, 1] \times U \rightarrow U$ such that:

- $\phi(0, \cdot) = Id$;
- $\exists K \subset\subset U$ such that $\forall t \phi(t, \cdot) = Id$ in K^c ;
- $\phi(1, \cdot)$ is Lipschitz;
- $\phi(t, x) \in \Gamma_i \forall t$ if $x \in \Gamma_i$.

Sliding boundary minimisers

Given $\Gamma := \cup_i \Gamma_i$ and $0 \leq \alpha \leq 1$ we define a new cost functional $c(E) := \mathcal{H}^d(E \setminus \Gamma) + \alpha \mathcal{H}^d(E \cap \Gamma)$ and we say that E is a sliding boundary minimiser if for any competitor F obtained as image of a sliding deformation we have $c(E \setminus F) \leq c(F \setminus E)$.

Minimal boundary cones

One-dimensional minimal cones in \mathbb{R}_+^2 , the sliding boundary $\Gamma := \{y = 0\}$ is in blue.

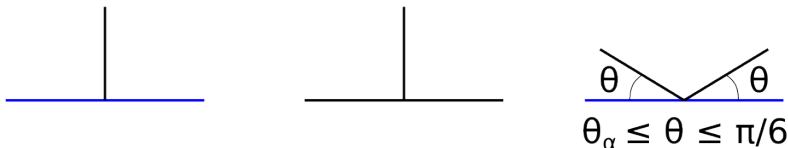
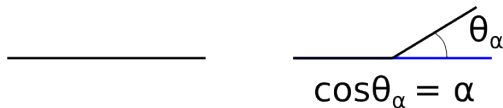

Minimal boundary cones

One-dimensional minimal cones in \mathbb{R}_+^3 , the sliding boundary $\Gamma := \{z = 0\}$ is in blue.

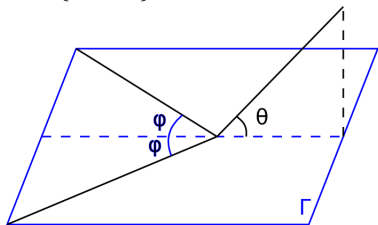

$$\theta_\alpha \leq \theta \leq \pi/2, \quad \pi/3 \leq \varphi \leq \pi/2$$
$$2\alpha \cos\varphi = \cos\theta$$

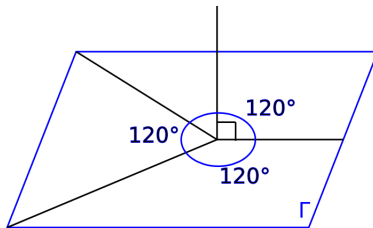

Minimal boundary cones

Two-dimensional cones in \mathbb{R}_+^3 , the sliding boundary $\Gamma := \{z = 0\}$ is in blue, the intersection between Γ and the cone is in grey.

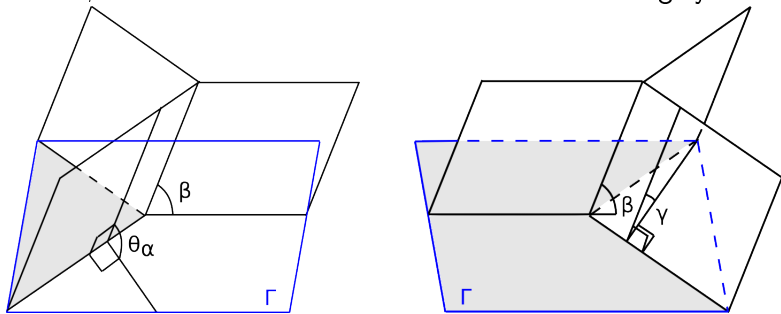

The two cones are minimal if and only if $\alpha = \frac{\sqrt{3}}{2} \cos \beta$.

Minimal boundary cones

Two-dimensional cones in \mathbb{R}_+^3 , the sliding boundary $\Gamma := \{z = 0\}$ is in blue, the intersection between Γ and the cone is in grey.

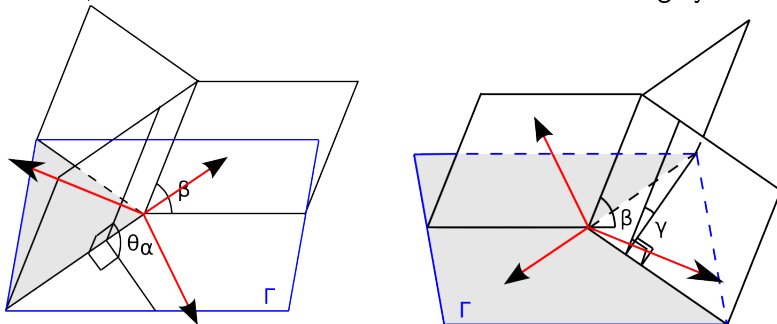

The two cones are minimal if and only if $\alpha = \frac{\sqrt{3}}{2} \cos \beta$.

Minimal boundary cones

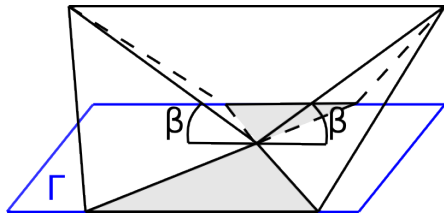

Again the cone is minimal if and only if $\alpha = \frac{\sqrt{3}}{2} \cos \beta$.

Minimal boundary cones

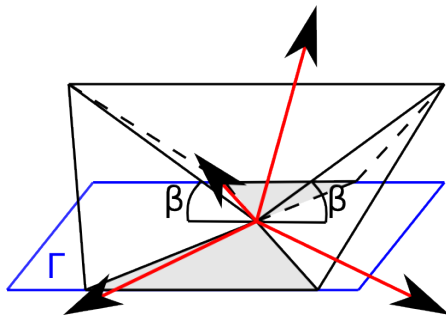

Again the cone is minimal if and only if $\alpha = \frac{\sqrt{3}}{2} \cos \beta$.

Minimal boundary cones

Let us set \mathbb{T}_+^2 as the cone over $sk_1(\Delta_3) \cap \mathbb{R}_+^3$, then \mathbb{T}_+^2 is a sliding minimal cone if $\alpha \geq \sqrt{\frac{2}{3}}$.

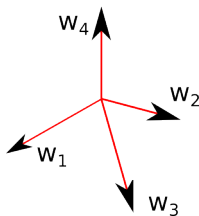
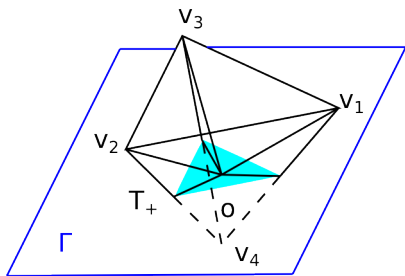

In general, let \mathbb{T}_+^{n-1} be the cone over $sk_{n-2}(\Delta_n) \cap \mathbb{R}_+^n$, then \mathbb{T}_+^{n-1} is a sliding minimal cone if $\alpha \geq \frac{1}{\sqrt{2}} \sqrt{\frac{n+1}{n}}$.

Non-minimal boundary cones

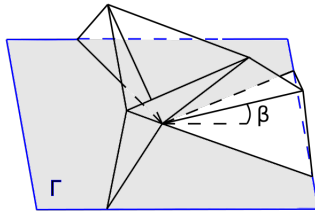
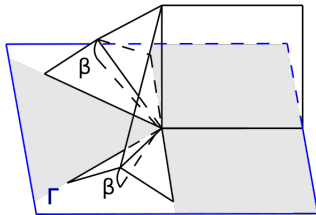
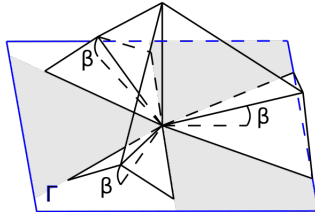
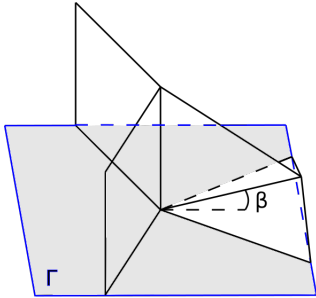

Singular boundary

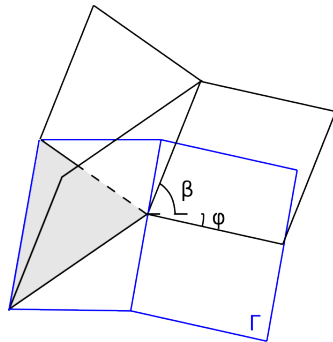
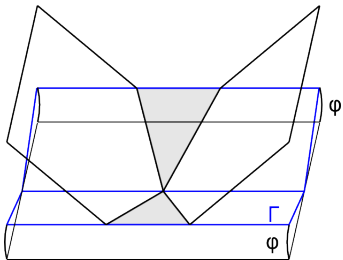

$$\alpha = \cos \varphi \cos \theta$$

Singular boundary

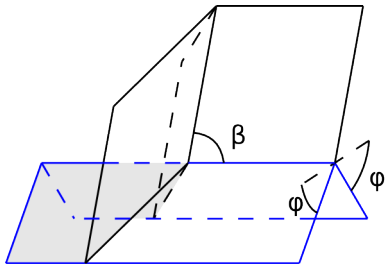

$$\alpha = \frac{\sqrt{3}}{2} \cos \beta \cos \varphi - \frac{\sin \varphi}{2}$$

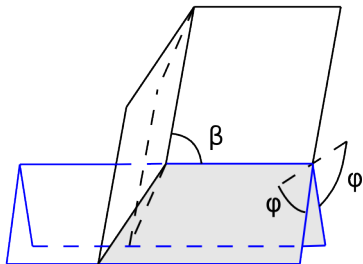

$$\alpha = -\frac{\sqrt{3}}{2} \cos \beta \cos \varphi + \frac{\sin \varphi}{2}$$

What's next?

- complete list
- higher dimensions
- regularity

THANK YOU FOR YOUR ATTENTION

